

LithgowLights Wiring Sheet

Cat 5 Cables

TIA/EIA 568A Wiring

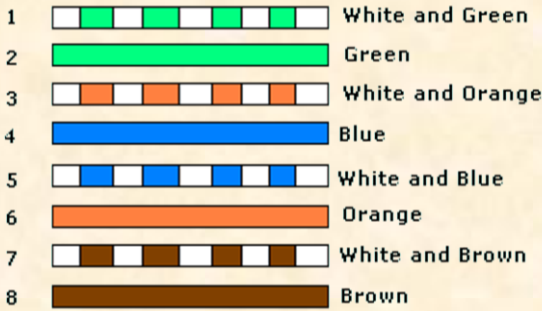

TIA/EIA 568B Wiring

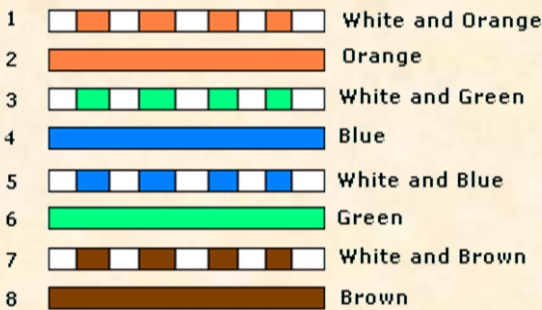

RJ45 Pins



External SSR's

- Pin 1 - Output 6
- Pin 2 - Output 5
- Pin 3 - Output 4
- Pin 4 - Output 3
- Pin 5 - Output 2
- Pin 6 - +5V
- Pin 7 - Output 1
- Pin 8 - N/C

Floodlight Resistors

- Red = 470Ω (26mA)
- Red = 510Ω (22mA)
- Red = 560Ω (20mA)
- Green = 180Ω (Old=270Ω)
- Blue = 270Ω (Old=220Ω)
- White = 270Ω

Floodlight DMX Connections (Male)



DMX Connections (Male)

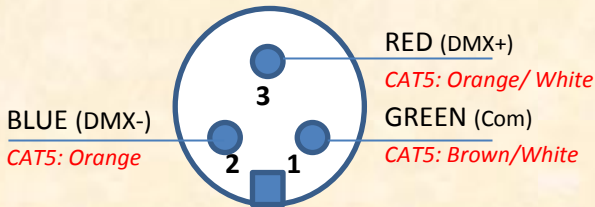

Power Connections (Male)

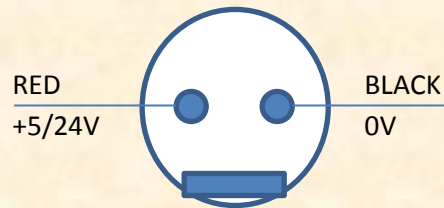

27 Chan Controller J12 Connection

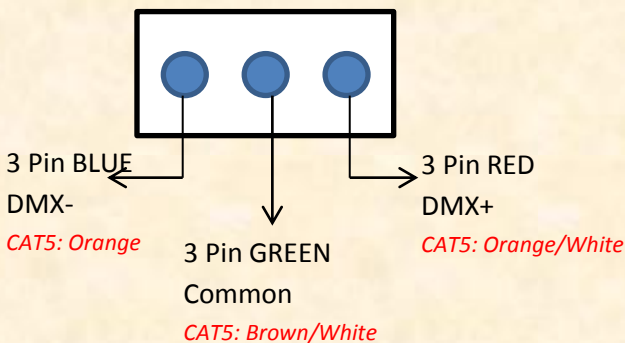

RGB LED Connections (Male)

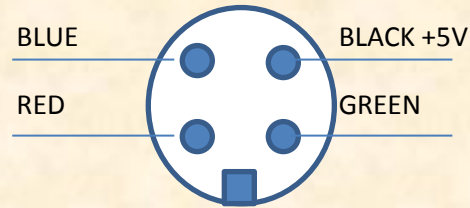

5 Wire Ropelight (Male)

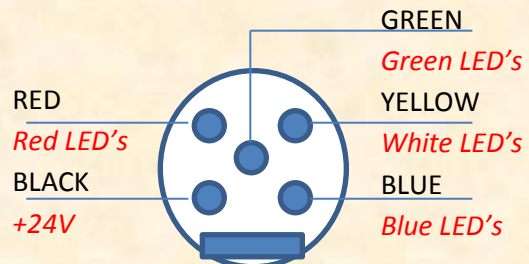

Tune To Signs (5050 2801's)

- In = Chip Side
- 5V+ = Red
- 0v = Black
- Data = Blue
- Clock = White